

# MCTRL4K

## LED Display Controller



# User Manual

Document Version: V1.1.1

Document Number: NS110100896

**Copyright © 2019 Xi'an NovaStar Tech Co., Ltd. All Rights Reserved.**

No part of this document may be copied, reproduced, extracted or transmitted in any form or by any means without the prior written consent of Xi'an NovaStar Tech Co., Ltd.

#### **Trademark**

 is a trademark of Xi'an NovaStar Tech Co., Ltd.

#### **Statement**

You are welcome to use the product of Xi'an NovaStar Tech Co., Ltd. (hereinafter referred to as NovaStar). This document is intended to help you understand and use the product. For accuracy and reliability, NovaStar may make improvements and/or changes to this document at any time and without notice. If you experience any problems in use or have any suggestions, please contact us via contact info given in document. We will do our best to solve any issues, as well as evaluate and implement any suggestions.

## Change History

Document Version	Hardware Version	Release Date	Description
V1.1.1	V1.2.4.0	2019-10-31	Updated the dimensions diagram.
V1.1.0	V1.2.4.0	2019-09-04	<ul style="list-style-type: none"> <li>• Added 3D function.</li> <li>• Added low latency function.</li> <li>• Added the function of individual Gamma adjustment for RGB.</li> <li>• Added HLG mode.</li> <li>• Added image quality adjustment function.</li> <li>• Added input source bit depth settings on control computer.</li> <li>• Added the function of importing user custom EDID.</li> <li>• Supports 25 Hz frame frequency.</li> <li>• Supports self-adaptation to decimal frame frequency.</li> <li>• Optimized HDR10 performance by adding low grayscale mode adjustment.</li> <li>• Optimized Mapping function schematic diagram.</li> </ul>
V1.0.3	V1.2.3.0	2018-02-08	Added HDR function.
V1.0.2	V1.2.2.0	2017-11-16	Supports Web control.
V1.0.1	N/A	2016-10-31	Updated document style.
V1.0.0	N/A	2016-06-06	First release

# Contents

<b>Change History .....</b>	<b>ii</b>
<b>1 Overview .....</b>	<b>1</b>
<b>2 Features .....</b>	<b>2</b>
<b>3 Applications .....</b>	<b>4</b>
<b>4 Cascading Devices .....</b>	<b>6</b>
<b>5 Hardware Structure .....</b>	<b>7</b>
5.1 Appearance .....	7
5.2 Dimensions .....	11
<b>6 Home Screen .....</b>	<b>12</b>
<b>7 Menu Operations .....</b>	<b>14</b>
7.1 Quick Screen Configuration .....	14
7.1.1 Step 1 Setting Input Mode .....	14
7.1.2 Step 2 Setting Input Resolution .....	15
7.1.3 Step 3 Quickly Configuring Screen .....	18
7.2 Brightness Adjustment .....	19
7.3 Screen Settings .....	19
7.3.1 Advanced Configuration .....	20
7.3.2 Image Offset .....	20
7.4 Display Control .....	20
7.5 Advanced Settings .....	21
7.5.1 Mapping Function .....	21
7.5.2 Loading Cabinet Files .....	22
7.5.3 Alarm Threshold Settings .....	23
7.5.4 Saving to Hardware .....	23
7.5.5 Redundancy .....	23
7.5.6 Factory Reset .....	23
7.5.7 HDR .....	24
7.5.8 3D Settings .....	27
7.5.9 Hardware Version .....	32
7.6 Communication Settings .....	32
7.7 Language .....	33
<b>8 Operations on PC .....</b>	<b>34</b>

---

8.1 Individual Gamma Adjustment for RGB.....	34
8.2 Low Latency.....	35
8.3 Input Source Bit Depth .....	37
8.4 Operations on Web Page .....	38
8.4.1 Environment Configuration .....	38
8.4.2 Operations .....	39
8.5 Software Operations on PC.....	39
8.5.1 NovaLCT.....	39
8.5.2 SmartLCT .....	40
8.6 Firmware Update .....	40
8.6.1 NovaLCT.....	40
8.6.2 SmartLCT .....	40
<b>9 Specifications .....</b>	<b>41</b>

# 1 Overview

The MCTRL4K is an LED display controller with ultra-large loading capacity developed by NovaStar. A single unit features a loading capacity of up to 4096×2160@60Hz. It supports any custom resolutions with the maximum width or height up to 7680 pixels, meeting the on-site configuration requirements of ultra-long or ultra-wide LED displays.

The MCTRL4K has many industry-leading advanced technologies:

- Supports HDR function, both in HDR10 and HLG standards, which can greatly enhance the image quality of the display, presenting more clear and vivid images.
- Supports individual Gamma adjustment for RGB when the bit depth of input source is 10-bit or 12-bit, which effectively controls image non-uniformity under low grayscale and white balance offset to improve image quality.
- Low latency: Less than 1 ms (when the start position of image is 0.)
- Supports 3D function when working with the 3D emitter EMT200 and 3D glasses, allowing you to experience 3D display effects.
- In multi-card mode, the MCTRL4K can be used as two controllers, allowing the images of two input sources to be displayed on the screen at the same time.

The MCTRL4K is stable, reliable and powerful, dedicated to providing a best visual experience. It is can be mainly used for the fixed and rental applications, such as concerts, live events, security monitoring, Olympic Games and various sports centers.

# 2 Features

- 1 x DP 1.2 input and 1 x HDMI 2.0 input, resolutions up to 8.8 million pixels per input
- 2 x D-DVI inputs, total resolutions up to 8.3 million pixels
- 16 x Neutrik Gigabit Ethernet ports and 4 x 10G optical ports for output
- Supported video bit depths: 8-bit, 10-bit and 12-bit
- Supports both mosaic and multi-card working modes for dual-link DVI inputs.
- Supports HDR function, both in HDR10 and HLG standards.
- Supports individual Gamma adjustment for RGB when the bit depth of input source is 10-bit or 12-bit.
- Supports 3D function when working with the 3D emitter EMT200 and 3D glasses.
- Low latency: Less than 1 ms (when the start position of image is 0.)
- Supports ultra-high resolution settings with NVIDIA graphics card.
- Adaptive to inputs with decimal frame frequencies, including 23.98 / 29.97 / 47.95 / 59.94 / 71.93 / 119.88 Hz
- Supports the new generation of pixel level calibration technology of NovaStar.
- Supports screen configuration via Web interface.
- Multiple MCTRL4K units can be cascaded together for uniform control.
- Supports a variety of video formats, as shown in [Table 2-1](#).

Table 2-1 Video formats

Input Connector	Features		
	Bit Depth	Sampling Format	Maximum Input Resolution
HDMI 2.0	8 bit	RGB 4:4:4 YCbCr 4:4:4 YCbCr 4:2:2 YCbCr 4:2:0	4096x2160@60Hz (Setting via NVIDIA graphics card)
	10 bit/12 bit	RGB 4:4:4 YCbCr 4:4:4	3840x1080@60Hz
		YCbCr 4:2:2	4096x2160@60Hz (Setting via NVIDIA graphics card)

Input Connector	Features		
	Bit Depth	Sampling Format	Maximum Input Resolution
DP 1.2	8 bit	YCbCr 4:2:0	4096x2160@60Hz (Setting via NVIDIA graphics card)
		RGB 4:4:4 YCbCr 4:4:4 YCbCr 4:2:2	
	10 bit/12 bit	RGB 4:4:4 YCbCr 4:4:4	3840x1080@60Hz
YCbCr 4:2:2		4096x2160@60Hz (Setting via NVIDIA graphics card)	
Dual-link DVI	8 bit	RGB 4:4:4 YCbCr 4:4:4 YCbCr 4:2:2	3840x1080@60Hz

**Note:**

When the input source bit depth is 10-bit/12-bit, you must set the bit depth correspondingly in NovaLCT. For detailed operations, see [8.3 Input Source Bit Depth](#).

# 3 Applications

The MCTRL4K can work in mosaic and multi-card modes, meeting multiple user application needs.

## Scenario 1: Application of Mosaic Mode

Figure 3-1 Application of mosaic mode

4K×2K  
LED Display

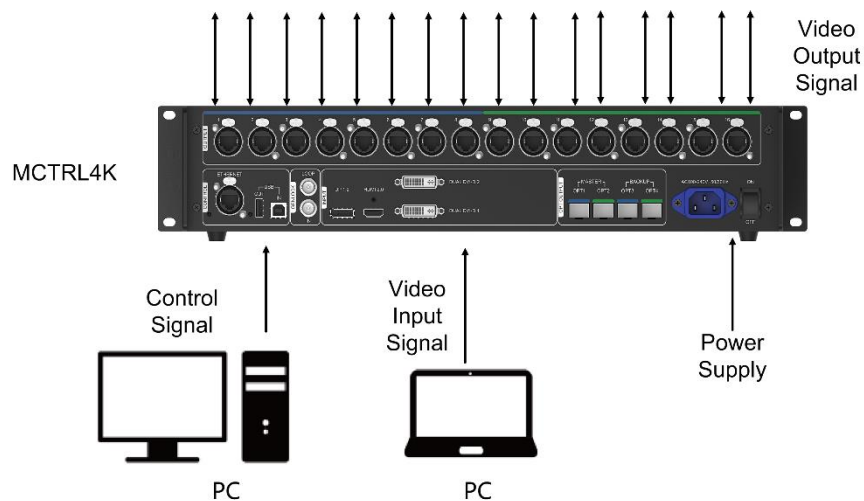
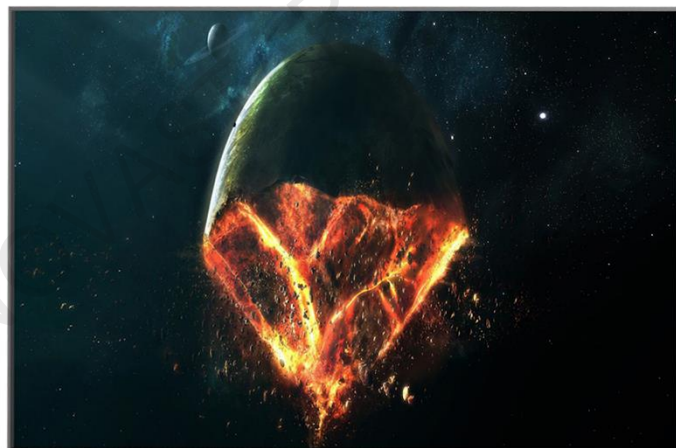

### Scenario 2: Application of Multi-Card Mode

Figure 3-2 Application of multi-card mode

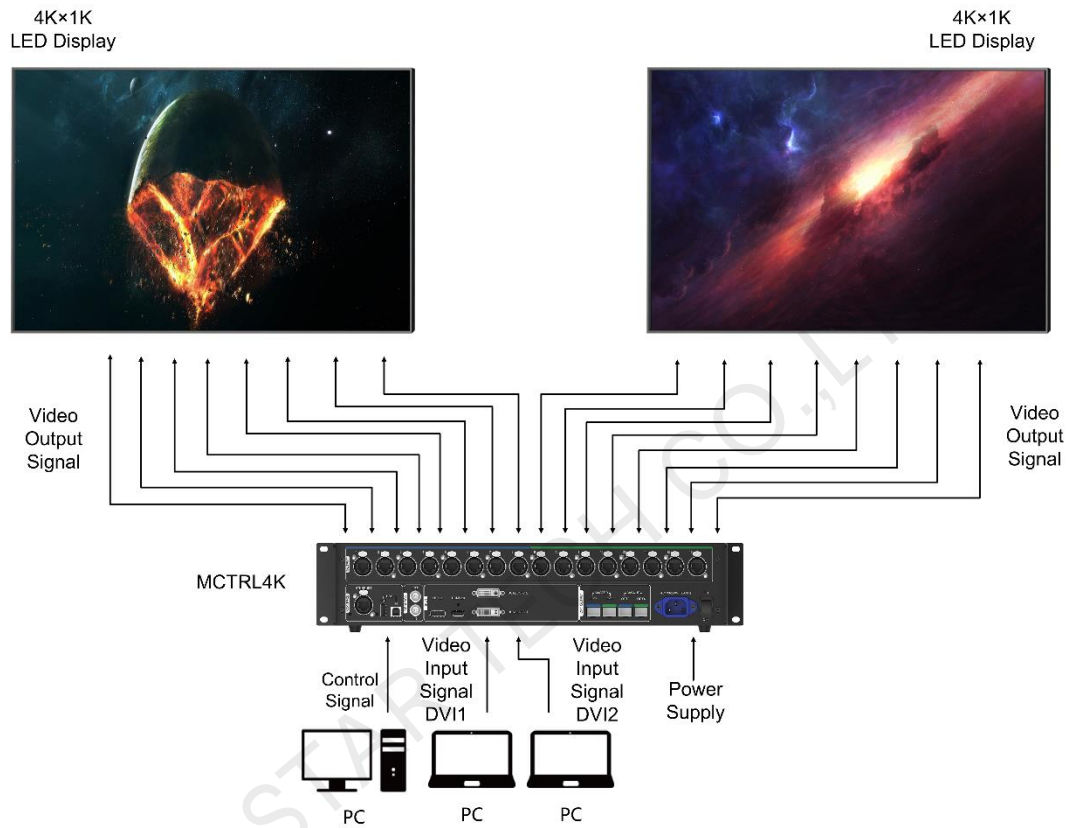

# 4 Cascading Devices

- The control computer needs to control multiple MCTRL4K devices. Cascade devices via USB IN and USB OUT ports of the MCTRL4K devices. Up to 10 devices can be cascaded.

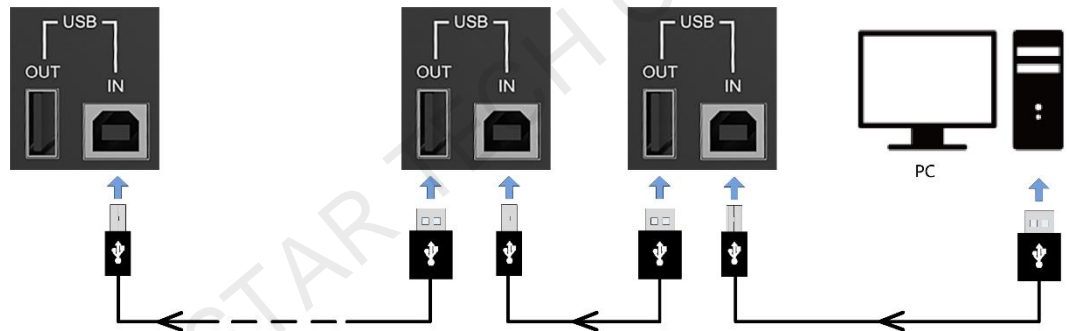

- Multiple MCTRL4K devices need to output image simultaneously. Cascade devices via GENLOCK IN and GENLOCK LOOP connectors of the MCTRL4K devices. Up to 10 devices can be cascaded.

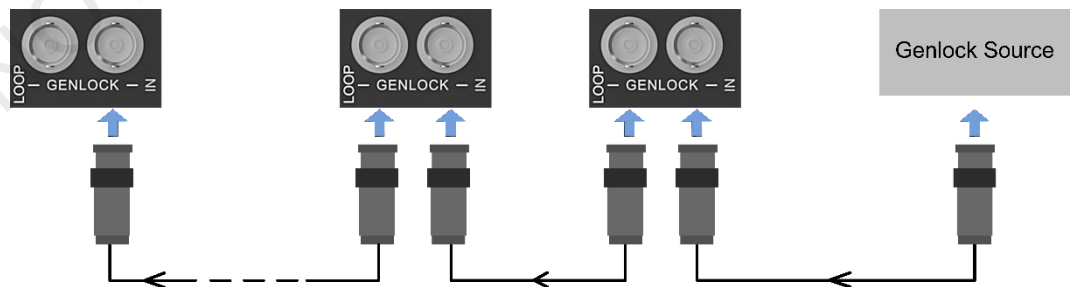

# 5 Hardware Structure

## 5.1 Appearance

### Front Panel



No.	Name	Description
1	Power button	Press to power on the device and hold down for 4–5 seconds to power off the device.
2	USB	Insert a USB drive only.
3	LCD screen	Display the menu.
4	Knob	<ul style="list-style-type: none"><li>• On the home screen, press the knob to enter the operation menu screen.</li><li>• On the operation menu screen, press the knob to select the current menu item or enter the submenu. Rotate the knob to select a menu item or adjust the parameter.</li><li>• Hold down the knob and <b>BACK</b> button at the same time for 5 seconds or longer to lock or unlock the buttons.</li></ul>
5	BACK	Exit the current menu or operation.

Rear Panel

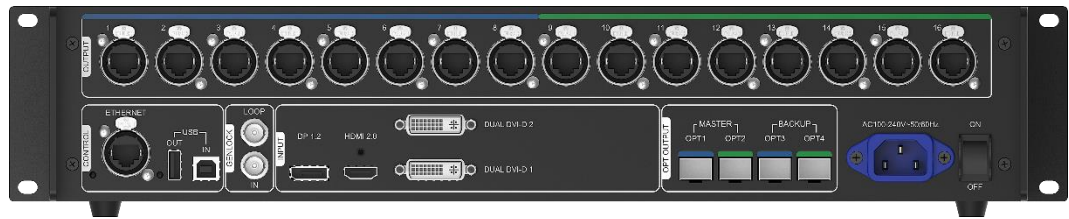

Input	
DP 1.2	<ul style="list-style-type: none"> <li>• DP 1.2 input, with a maximum resolution of 4096x2160@60Hz and minimum resolution of 640x480@24Hz</li> <li>• Pixel capacity: 8,800,000 pixels</li> <li>• Custom resolutions supported: Resolution limit with maximum width: 7680x1080@60Hz Resolution limit with maximum height: 1080x7680@60Hz</li> <li>• Supports HDCP 1.3.</li> <li>• Supported standard resolutions: 1280x1024@(24/25/30/48/50/60/72/75/85/100/120)Hz 1366x768@(24/25/30/48/50/60/72/75/85/100/120)Hz 1440x900@(24/25/30/48/50/60/72/75/85/100/120)Hz 1600x1200@(24/25/30/48/50/60/72/75/85/100/120)Hz 1920x1080@(24/25/30/48/50/60/72/75/85/100/120)Hz 1920x1200@(24/25/30/48/50/60/72/75/85/100/120)Hz 1920x2160@(24/25/30/48/50/60/72/75/85/100/120)Hz 2560x1600@(24/25/30/48/50/60/72/75/85/100/120)Hz 3840x1080@(24/25/30/48/50/60/72/75/85/100/120)Hz 3840x2160@(24/25/30/48/50/60)Hz</li> </ul>
HDMI 2.0	<ul style="list-style-type: none"> <li>• HDMI 2.0 input, with a maximum resolution of 4096x2160@60Hz and minimum resolution of 800x600@30Hz</li> <li>• Pixel capacity: 8,800,000 pixels</li> <li>• Custom resolutions supported: Resolution limit with maximum width: 7680x1080@60Hz Resolution limit with maximum height: 1080x7680@60Hz</li> <li>• Supports HDCP 1.4 and HDCP 2.2.</li> <li>• Supported standard resolutions: 1280x1024@(24/25/30/48/50/60/72/75/85/100/120)Hz 1440x900@(24/25/30/48/50/60/72/75/85/100/120)Hz 1600x1200@(24/25/30/48/50/60/72/75/85/100/120)Hz 1920x1080@(24/25/30/48/50/60/72/75/85/100/120)Hz 1920x1200@(24/25/30/48/50/60/72/75/85/100/120)Hz 1920x2160@(24/25/30/48/50/60/72/75/85/100/120)Hz 2048x1536@(24/25/30/48/50/60/72/75/85/100/120)Hz</li> </ul>

	<p>2560×1600@(24/25/30/48/50/60/72/75/85/100/120)Hz  3840×1080@(24/25/30/48/50/60/72/75/85/100/120)Hz  3840×2160@(24/25/30/48/50/60)Hz</p>
DUAL DVI-D1 DUAL DVI-D2	<ul style="list-style-type: none"> <li>• 2 × DVI inputs, each with a maximum resolution of 3840×1080@60Hz and minimum resolution of 800×600@30Hz</li> <li>• Pixel capacity: 8,300,000 pixels</li> <li>• Custom resolutions supported: <ul style="list-style-type: none"> <li>Resolution limit with maximum width: 3840×2160@60Hz</li> <li>Resolution limit with maximum height: 2160×3840@60Hz</li> </ul> </li> <li>• Supported standard resolutions: <ul style="list-style-type: none"> <li>1280×1024@(24/25/30/48/50/60/72/75/85/100/120)Hz</li> <li>1366×768@(24/25/30/48/50/60/72/75/85/100/120)Hz</li> <li>1440×900@(24/25/30/48/50/60/72/75/85/100/120)Hz</li> <li>1600×1200@(24/25/30/48/50/60/72/75/85/100/120)Hz</li> <li>1920×1080@(24/25/30/48/50/60/72/75/85/100/120)Hz</li> <li>1920×1200@(24/25/30/48/50/60/72/75/85/100)Hz</li> <li>1920×2160@(24/25/30/48/50/60)Hz</li> <li>2560×1600@(24/25/30/48/50/60)Hz</li> <li>3840×1080@(24/25/30/48/50/60)Hz</li> <li>3840×2160@(24/25/30)Hz</li> </ul> </li> </ul>
<b>Output</b>	
1–16	<ul style="list-style-type: none"> <li>• 16 Neutrik (NE8FBH) Gigabit Ethernet ports</li> <li>• Maximum loading capacity of a single Ethernet port: <ul style="list-style-type: none"> <li>– For 8-bit input sources: 650,000 pixels</li> <li>– For 10-bit/12-bit input sources: 320,000 pixels</li> </ul> </li> <li>• Do not support audio output.</li> <li>• Support redundancy between Ethernet ports.</li> </ul>
OPT1–OPT4	<ul style="list-style-type: none"> <li>• 10G optical ports <ul style="list-style-type: none"> <li>– Single-mode twin-core fiber: Support LC optical connectors; wavelength: 1310 nm; transmission distance: 10 km; OS1/OS2 recommended.</li> <li>– Dual-mode twin-core fiber: Support LC optical connectors; wavelength: 850 nm; transmission distance: 300 m; OM3/OM4 recommended.</li> </ul> </li> <li>• The maximum loading capacity of a single optical port equals to that of all the 8 Ethernet ports.</li> <li>• 4 OPT inputs/outputs <ul style="list-style-type: none"> <li>– OPT1 and OPT2 are main input/output ports. OPT1 corresponds to Ethernet ports 1–8 and OPT2 corresponds to Ethernet ports 9–16.</li> <li>– OPT3 and OPT4 are backup input/output ports. OPT3 is a duplicate channel of OPT1, and OPT4 is a duplicate channel of OPT2.</li> </ul> </li> </ul>

Control	
ETHERNET	For PC connection
USB IN	Input port for cascading devices, or connecting to PC
USB OUT	Output port for cascading devices
GENLOCK	
IN	GENLOCK input connector <ul style="list-style-type: none"> <li>• Genlock type: Blackburst</li> <li>• Input Genlock sync signal to ensure synchronization and same refresh rate between the output signals of cascaded MCTRL4K units and the external Genlock signal.</li> </ul>
LOOP	Genlock loop output connector Up to 10 MCTRL4K units can be cascaded.
Power	
AC 100 V–240 V, 50/60Hz	AC power input

## Note:

- Type-A USB port is prohibited from being connected to the control computer directly.
- This product can only be worked horizontally. Wall mounting is not permitted.

## 5.2 Dimensions

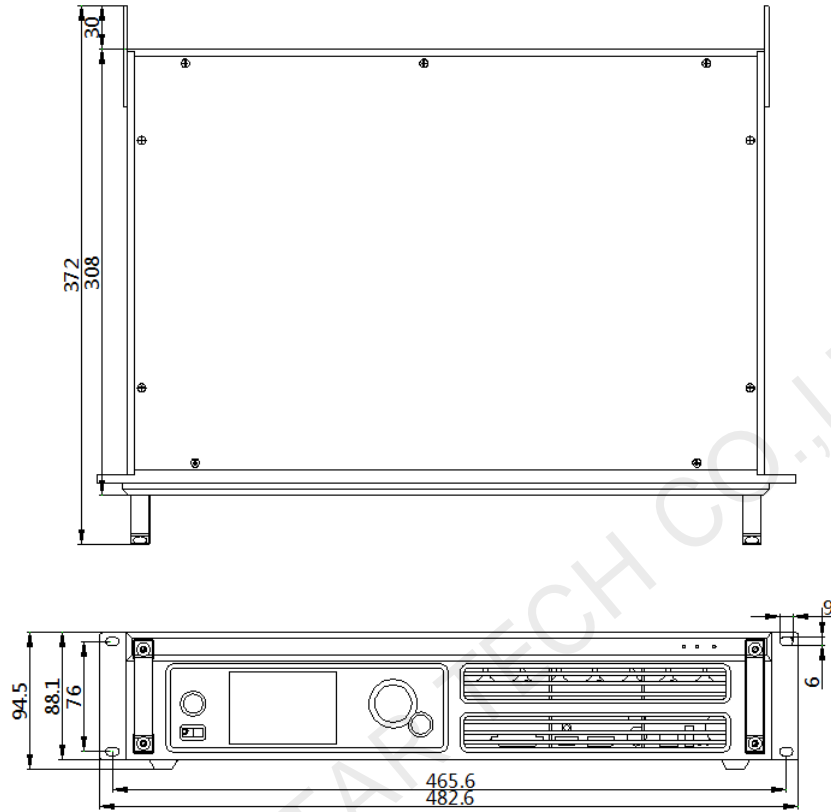

Unit: mm



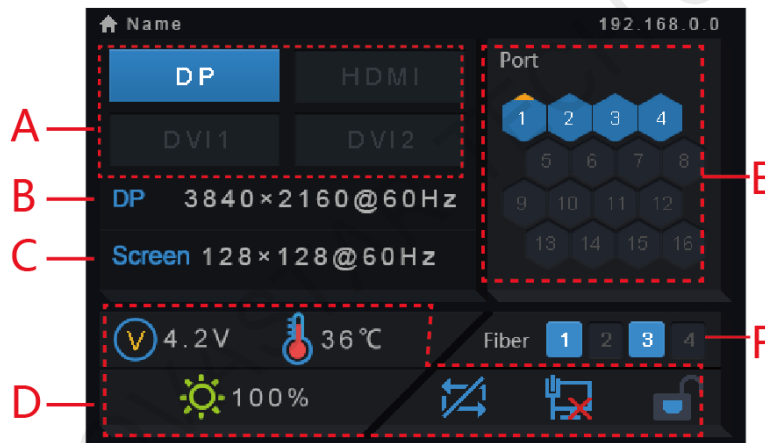

# 6 Home Screen

After the MCTRL4K is powered on, its home screen appears, as shown in [Figure 6-1](#).

Figure 6-1 Home screen



No.	Description	
A	Access status of signal sources: <ul style="list-style-type: none"> <li>• On: Signal available</li> <li>• Off: Signal unavailable</li> </ul> The interval between unplugging and plugging the DP source must be greater than 5 seconds. Otherwise, the DP source cannot be detected.	
B	Display the current input source information, including source type, resolution and frame frequency. In multi-card mode, both DVI1 and DVI2 have input sources. The information about the two DVI sources will be displayed alternately.	
C	Display the resolution and frame frequency of the currently configured LED display.	
D		Supply voltage of motherboard
		Temperature inside the controller

No.	Description	
		Brightness of LED display
		3D function is enabled (This icon is not displayed when the function is disabled).
		Status of DVI1 and DVI2 sources: In sync/Not in sync
		Status of the control port: USB connected/Ethernet connected/Not connected
		Status of buttons on the front panel: Locked/Unlocked
E	<p>Ethernet port connection status</p> <ul style="list-style-type: none"> <li>• Always on: The Ethernet port connection works and the port serves as master.</li> <li>• Off: The Ethernet port is not connected or the connection does not work.</li> <li>• Always on and a mark (not flashing) on top corner of icon: The Ethernet port is in redundancy status, but the redundancy has not taken effect.</li> <li>• Always on and a mark (flashing) on top corner of icon: The Ethernet port is in redundancy status and the redundancy has taken effect.</li> </ul>	
F	<p>OPT1/OPT2: Master optical ports OPT1 corresponds to Ethernet ports 1–8 and OPT2 corresponds to Ethernet ports 9–16. Their statuses are as below.</p> <ul style="list-style-type: none"> <li>• Always on: The optical port connection works and the port serves as master.</li> <li>• Off: The optical port is not connected or the connection does not work.</li> </ul> <p>OPT3/OPT4: Backup optical ports OPT3 works as the backup of OPT1, and OPT4 as the backup of OPT2. Their statuses are as below.</p> <ul style="list-style-type: none"> <li>• Off: The optical port is not connected or the connection does not work.</li> <li>• Always on: The optical port connection works, but the redundancy has not taken effect.</li> <li>• Always on and a mark on top-right corner of icon: The optical port connection works and the redundancy has taken effect.</li> </ul>	

**Note:**

When the home screen is locked, any button operations will be disabled and an icon will appear indicating that the device is locked.

To perform operations on the home screen, hold down the knob and **BACK** button for 5 seconds or longer at the same time to unlock the buttons.

# 7 Menu Operations

The MCTRL4K is powerful and easy to use. You can quickly configure the LED screen to light it up and display the entire input source following steps in [7.1 Quick Screen Configuration](#). With other menu settings, you can further improve the LED screen display effect.

## 7.1 Quick Screen Configuration

### 7.1.1 Step 1 Setting Input Mode

The input mode settings include DVI mode, input source and mosaic mode settings.

Figure 7-1 Input mode settings

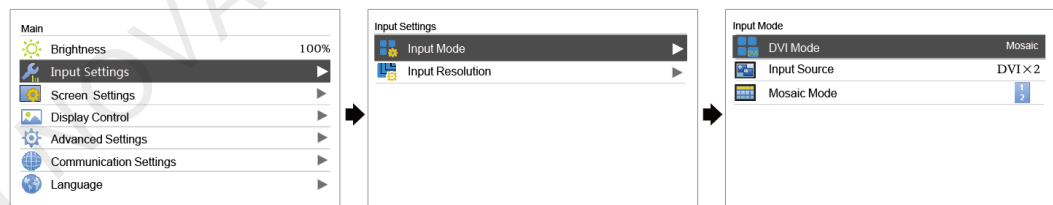

- In mosaic mode, the input source can be **Auto**, **DP**, **HDMI** or **DVIx2**.
  - When the input source is **Auto**, the device will detect the inputs automatically in the order of DP > HDMI > DVI.
  - In this mosaic mode, you can set the DVI mosaic mode. The mosaic mode can be "top and bottom" or "side by side".
- In multi-card mode, the input sources can be **DVI 1** and **DVI 2**.
  - The MCTRL4K works as two independent sending cards and the loading capacity of each card is up to 3840×1080@60Hz. The images of both DVI 1 and DVI 2 input sources can be displayed on LED display simultaneously, but they cannot be set at the same time.
  - The DVI 1 corresponds to Ethernet ports 1–8 or OPT1, and DVI 2 corresponds to Ethernet ports 9–16 or OPT2.

## 7.1.2 Step 2 Setting Input Resolution

The input resolution can be set to a preset resolution or can be customized.

Figure 7-2 Input resolution settings

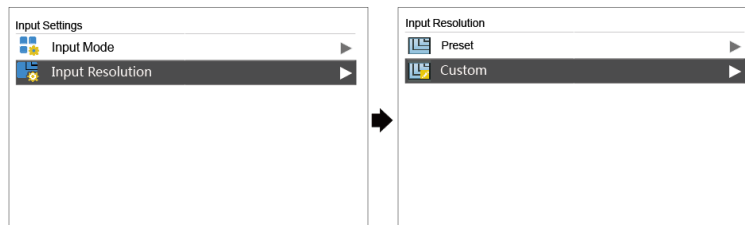

The input resolution can be set through the following methods.

### Method 1: Preset

Select an appropriate resolution from the preset standard resolutions.

When the input source is DVI, supported preset resolutions include:

- 1280×1024@(24/25/30/48/50/60/72/75/85/100/120)Hz
- 1366×768@(24/25/30/48/50/60/72/75/85/100/120)Hz
- 1440×900@(24/25/30/48/50/60/72/75/85/100/120)Hz
- 1600×1200@(24/25/30/48/50/60/72/75/85/100/120)Hz
- 1920×1080@(24/25/30/48/50/60/72/75/85/100/120)Hz
- 1920×1200@(24/25/30/48/50/60/72/75/85/100)Hz
- 1920×2160@(24/25/30/48/50/60)Hz
- 2560×1600@(24/25/30/48/50/60)Hz
- 3840×1080@(24/25/30/48/50/60)Hz
- 3840×2160@(24/25/30)Hz

When the input source is HDMI, supported preset resolutions include:

- 1280×1024@(24/25/30/48/50/60/72/75/85/100/120)Hz
- 1440×900@(24/25/30/48/50/60/72/75/85/100/120)Hz
- 1600×1200@(24/25/30/48/50/60/72/75/85/100/120)Hz
- 1920×1080@(24/25/30/48/50/60/72/75/85/100/120)Hz
- 1920×1200@(24/25/30/48/50/60/72/75/85/100/120)Hz
- 1920×2160@(24/25/30/48/50/60/72/75/85/100/120)Hz
- 2048×1536@(24/25/30/48/50/60/72/75/85/100/120)Hz
- 2560×1600@(24/25/30/48/50/60/72/75/85/100/120)Hz
- 3840×1080@(24/25/30/48/50/60/72/75/85/100/120)Hz
- 3840×2160@(24/25/30/48/50/60)Hz

When the input source is DP, supported preset resolutions include:

- 1280x1024@(24/25/30/48/50/60/72/75/85/100/120)Hz
- 1366x768@(24/25/30/48/50/60/72/75/85/100/120)Hz
- 1440x900@(24/25/30/48/50/60/72/75/85/100/120)Hz
- 1600x1200@(24/25/30/48/50/60/72/75/85/100/120)Hz
- 1920x1080@(24/25/30/48/50/60/72/75/85/100/120)Hz
- 1920x1200@(24/25/30/48/50/60/72/75/85/100/120)Hz
- 1920x2160@(24/25/30/48/50/60/72/75/85/100/120)Hz
- 2560x1600@(24/25/30/48/50/60/72/75/85/100/120)Hz
- 3840x1080@(24/25/30/48/50/60/72/75/85/100/120)Hz
- 3840x2160@(24/25/30/48/50/60)Hz

---

Note:

The MCTRL4K supports self-adaptation to decimal frame frequencies (23.98/29.97/47.95/59.94/71.93/119.88 Hz).

---

## Method 2: Custom

Set a custom width, height and refresh rate.

- Step 1 Press the knob to enter the main menu.
- Step 2 Choose **Input Settings** > **Input Resolution** > **Custom** and set the width, height and refresh rate.
- Step 3 Select **Apply** and press the knob to apply the settings.

## Method 3: Ultra-High Resolution Settings

When the input source is DP/HDMI, you can set an ultra-high resolution via the NVIDIA graphics card of the computer. The width or height is up to 7680 pixels.

Recommended graphics cards: NVIDIA GeForce GTX 970, NVIDIA GeForce GTX 1060, and NVIDIA GeForce GTX 750 Ti

---

Note:

When the width or height of the output image is greater than 4092 pixels, the resolution must be customized only via the NVIDIA graphics card.

---

- Step 1 Right-click on desktop.
- Step 2 Select **NVIDIA Control Panel**.
- Step 3 On the left panel, choose **Display** > **Change resolution**. On the right area, select the controller you want to set.

Figure 7-3 Changing resolution

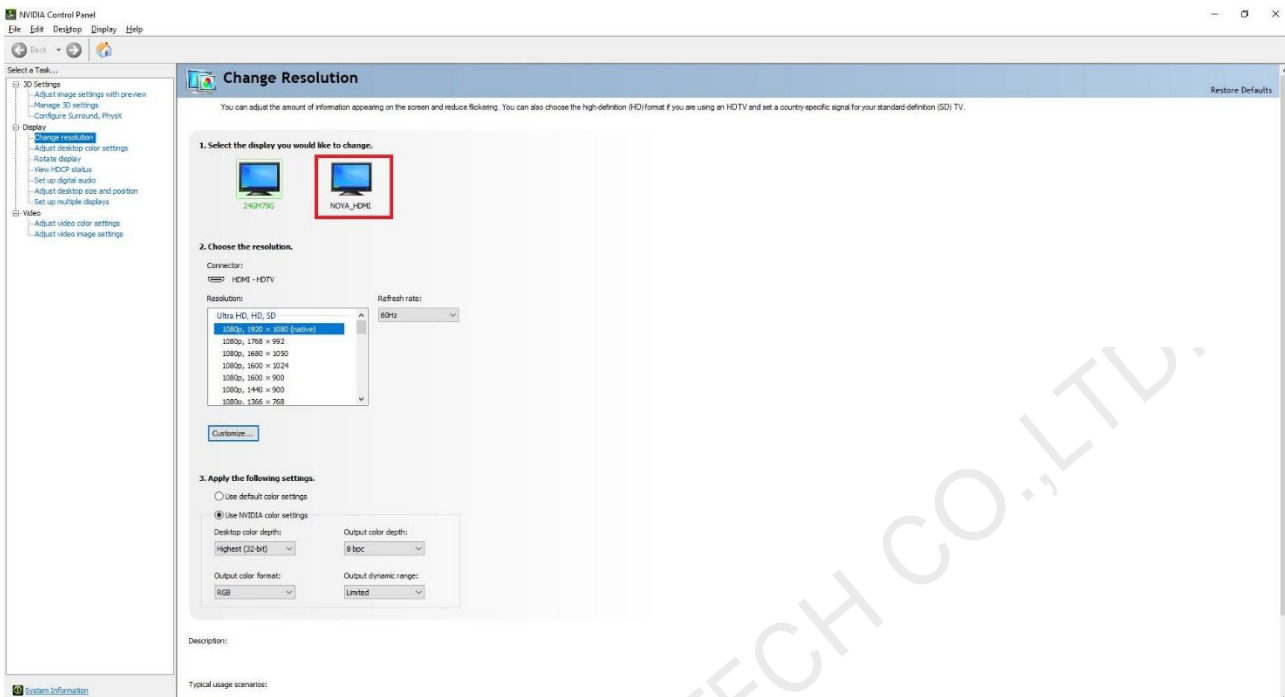

Step 4 Click **Customize** under **2. Apply the following settings**. In the **Customize** dialog box that appears, click **Create Custom Resolution**. In the **Create Custom Resolution** dialog box that appears, set the parameters.

- When you set the timing standard to **Manual**, use the *MCTRL4K Ultra-High Resolution Settings Generator* to calculate the parameters, including active pixels, front porch (pixels), sync width (pixels), polarity, total pixels and refresh rate. Then enter the parameter values manually. Note that the pixel clock must not be greater than 595.0 MHz.
- When you set the timing standard to **CVT reduced blank**, the software will calculate the parameters automatically and they cannot be changed manually.

Figure 7-4 Creating custom resolution

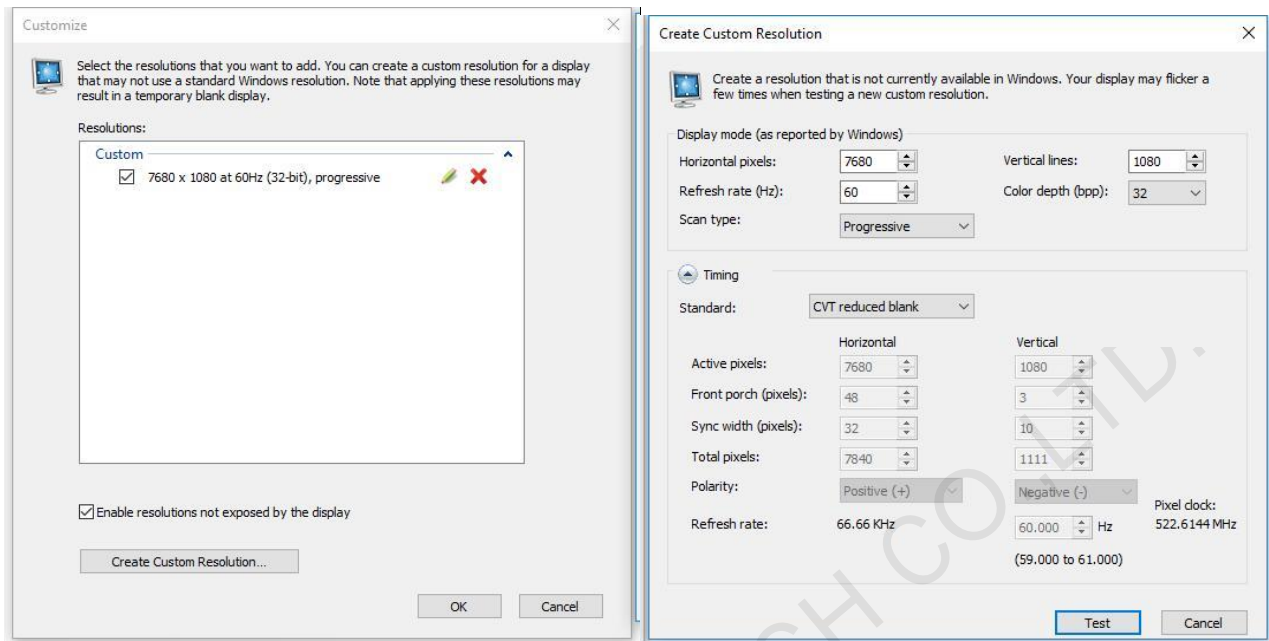

Step 5 Click **Test**. In the displayed dialog box indicating the test is successful, click **Yes** to save the custom resolution.

### 7.1.3 Step 3 Quickly Configuring Screen

This function is used to quickly configure a screen.

Step 1 Press the knob to enter the main menu.

Step 2 Choose **Screen Settings > Quick Config** to enter the submenu.

Step 3 Enable **Quick Config** and set the parameters.

- Set **Cabinet Row QTY** and **Cabinet Col QTY** (number of cabinet rows and columns to be loaded).
- Set **Port 1 Cabinet QTY** (number of cabinets loaded by Ethernet port 1). The device has restrictions on loading capacity of the Ethernet ports. For details, see Note a).
- Set **Data Flow** of the screen. For details, see Note c), d), and e).

Figure 7-5 Quick configuration

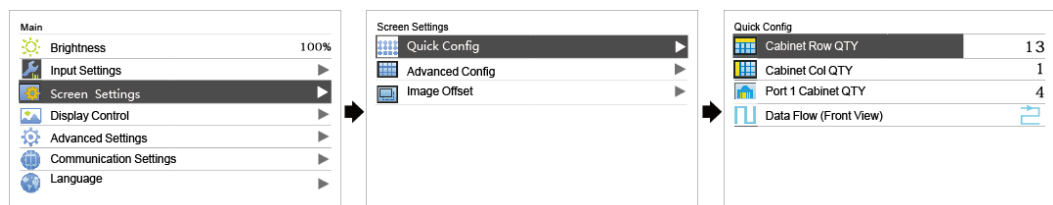

**Note**

a). If n ports are used to load the screen, the

Example:

<p>number of cabinets loaded by the first (n-1) ports must be:</p> <ol style="list-style-type: none"> <li>1. the same;</li> <li>2. the integral multiple of the number of rows or columns;</li> <li>3. no less than the number of cabinets loaded by the last port.</li> </ol>	<p>If Ethernet ports 1-16 are used to load the screen, the number of cabinets loaded by ports 1-15 must be the same and the integral multiple of the number of rows or columns. Therefore, you need to set only the number of cabinets loaded by port 1 according to the actual situation. The number of cabinets loaded by port 16 must be less than or equal to the number of cabinets loaded by port 1.</p> <p>In multi-card mode, if DVI 2 is used as input, the corresponding output ports are ports 9-16. That is, port 9 is considered as the first port. So it is required to set the number of cabinets loaded by port 9.</p>
<p>b). If there are irregular cabinets, cabinets of different sizes, or irregular screens, it is required to connect NovalCT software for screen configuration.</p>	
<p>c). During data flow settings, you can view the results of different data flow presets on LED display by rotating the knob. When you are satisfied with the LED display image effect, press the knob to save the settings.</p>	
<p>d). During data flow settings, you must ensure that the physical connection of each port is along the same direction and downward to next one.</p>	
<p>e). During data flow settings, you must ensure that the Ethernet Port 1 is at the beginning position of the whole physical connection.</p>	

## 7.2 Brightness Adjustment

On the main menu, press the knob to select **Brightness** and rotate the knob to adjust the brightness value of the LED display in real time.

Figure 7-6 Brightness adjustment

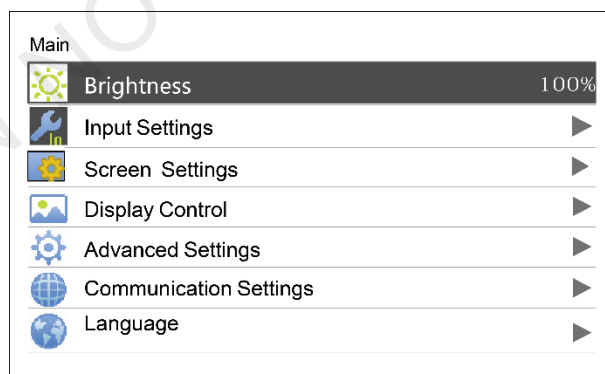

## 7.3 Screen Settings

Configure the LED screen to ensure the screen can display the entire image normally.

Screen settings methods include quick and advanced configurations. There are constraints on these methods, explained as below.

- The two methods cannot be used at the same time.

- Do not use any of the two methods on MCTRL4K to configure the screen again after the screen is configured the in NovaLCT.

### 7.3.1 Advanced Configuration

Figure 7-7 Advanced configuration

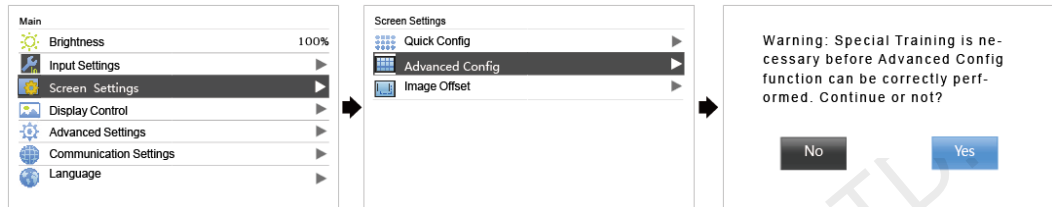

- Step 1 Choose **Advanced Config** and press the knob to enter its submenu.
- Step 2 On the warning screen, click **Yes** to enter the advanced configuration screen.
- Step 3 Select **Enable**, select an Ethernet port and set its parameters, including **Cabinet Row Qty**, **Cabinet Column Qty**, **Start X**, **Start Y** and **Data Flow**. At last, click **Apply**.
- Step 4 Select the next Ethernet port to continue setting until all the ports are set.

### 7.3.2 Image Offset

After configuring the screen, adjust the horizontal and vertical offsets (**Start X** and **Start Y**) of the overall displayed image to ensure it is displayed in the target position.

Figure 7-8 Image offset

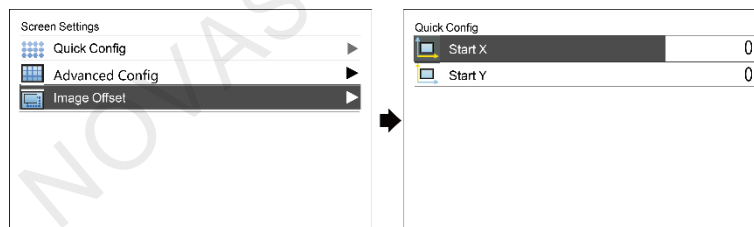

## 7.4 Display Control

Figure 7-9 Display control

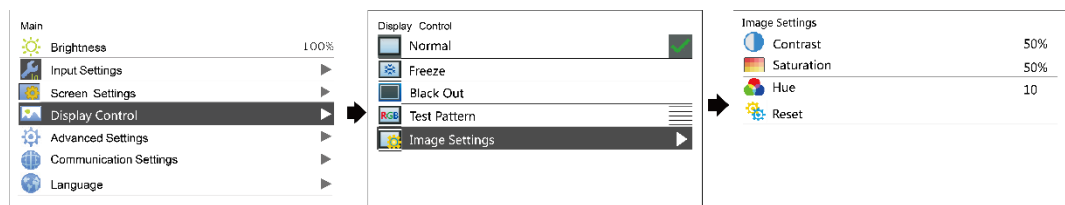

- Normal: The LED screen displays the current input source normally.
- Black Out: The LED screen goes black and does not display input source still being played in the background.

- Freeze: The LED screen always displays the frame when frozen. The input source is still being played in the background.
- Test Pattern: Test patterns are used to check the display effect and pixel operating status. There are 8 test patterns, including pure colors and line patterns.
- Image Settings: The settings are used to adjust the contrast, saturation and hue of the output image in order to improve the display effect.

Parameter	Description
Contrast	Range: 0%–100%; step: 1%
Saturation	Range: 0%–100%; step: 1%
Hue	Range: -180–+180; step: 1

Notice:

When the calibration function is enabled, image settings are unavailable.

## 7.5 Advanced Settings

Figure 7-10 Advanced Settings

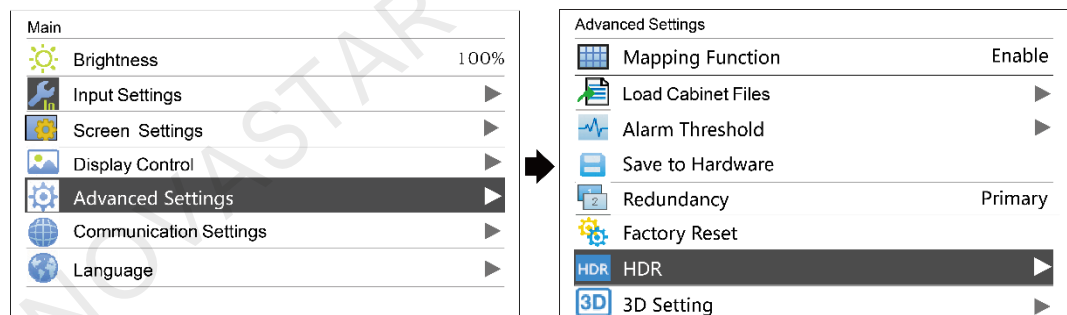

### 7.5.1 Mapping Function

When mapping function is enabled, each of the cabinets will display its cabinet No. and the No. of the Ethernet port that loads the cabinet.

Note: Receiving cards used by the system must support mapping function.

Figure 7-11 Illustration of mapping function



Example: **P: 01** indicates the Ethernet port No. **#001** indicates the cabinet No.

Notice:

The receiving card used in the system must support Mapping function.

## 7.5.2 Loading Cabinet Files

Before you begin: Save the cabinet configuration file (\*.rcfgx or \*.rcfg) to the local PC.

Note: Configuration files of irregular cabinets are not supported.

- Step 1 Run NovaLCT and choose **Tools > Controller Cabinet Configuration File Import**.
- Step 2 On the displayed page, select the currently used serial port or Ethernet port, click **Add Configuration File** to select and add a cabinet configuration file.
- Step 3 Click **Save the Change to HW** to save the change to the controller.

Figure 7-12 Homepage of NovaLCT

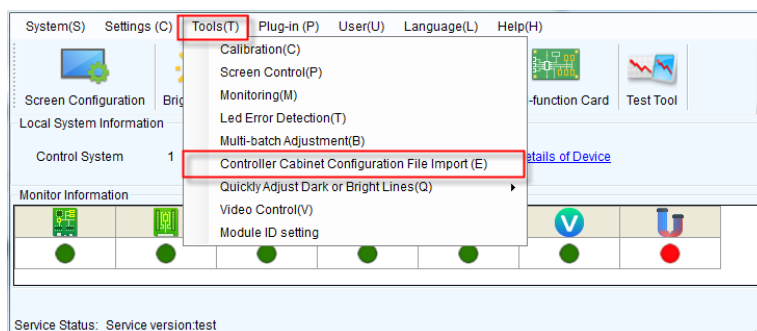
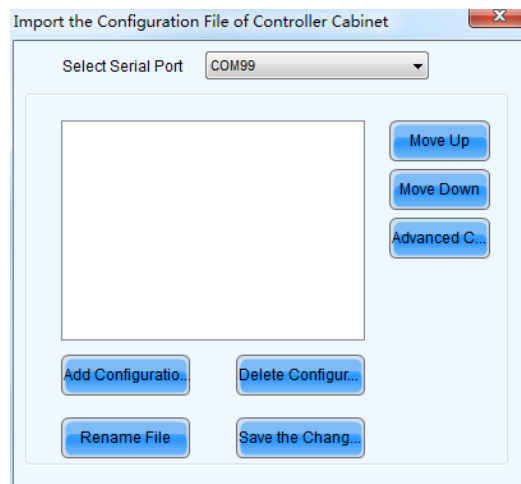



Figure 7-13 Importing cabinet configuration file



### 7.5.3 Alarm Threshold Settings

Set the alarm thresholds for device temperature and voltage. When a threshold is exceeded, its corresponding icon will be flashing, instead of displaying the value.

-  : Voltage alarm. The voltage value is in red and flashing. The voltage threshold range is 3.5 V–7.5 V.
-  : Temperature alarm. The temperature value is in red and flashing. The temperature threshold range is -20°C–85°C.

### 7.5.4 Saving to Hardware

Send and save the configuration parameters of the controller to the receiving cards and those parameters will not be lost after the controller is powered off.

### 7.5.5 Redundancy

Set the controller as the primary or backup device.

- If the controller is set as the primary device, the target Ethernet port(s) on the home screen will be always on.
- If the controller is set as the backup device, the target Ethernet port(s) on the home screen will be always on and a mark is displayed on top corner of the port icon.

When the primary device fails, the backup device will immediately take over the work of the primary device, that is, the backup takes effect. After the backup takes effect, the target Ethernet port icons in the home screen will have marks on top flashing once every 1 second.

### 7.5.6 Factory Reset

Reset the controller to factory settings.

## 7.5.7 HDR

HDR is short for high dynamic range. The HDR function of the MCTRL4K works with the A8s or A10s Plus receiving card to greatly enhance the image quality of the screen, presenting more clear and vivid images.

The HDR supports HDR10 and HLG standards. You can use the following two methods to enable HDR function and set its parameters.

### Method 1: Operation on LCD Menu

Step 1 Choose **Advanced Settings > HDR** and enable HDR function.

Step 2 Select an HDR type from HDR10 and HLG.

- When the input source is HDR10, you can set **Screen Peak Luma**, **Ambient Light** and **Low Grayscale Mode** to adjust the display effect.
- When the input source is HLG, you can select one HLG mode from the 7 modes, namely HLG1 (300 nits) to HLG7 (1700 nits).

Standard	Parameter	Description
HDR10	Screen Peak Luma	Range: 100–10000; step: 10 Used to adjust the brightness during normal operating of the screen
	Ambient Light	Range: 0–30; step: 10 Used to display the brightness of ambient light radiated to the screen (You need to enter the brightness value after measuring.)
	Low Grayscale Mode	Range: 0–50; step: 1 Used to improve the image display effect. The bigger the value is, the clearer the details in shadows will be.
HLG	HLG Mode	A total of 7 HLG modes supported, including HLG1 (300 nits), HLG2 (450 nits), HLG3 (600 nits), HLG4 (750 nits), HLG5 (1000 nits), HLG6 (1300 nits) and HLG7 (1700 nits) Used to adjust the image display effect. You can select a mode based on the actual screen peak Luma value. At the same time, you can try the adjacent HLG modes based on the on-site ambient light brightness to see their effects and select the best mode.

Step 3 (Optional) Choose **Rest** to reset the HDR settings to factory settings.

Figure 7-14 HDR10 operation menu

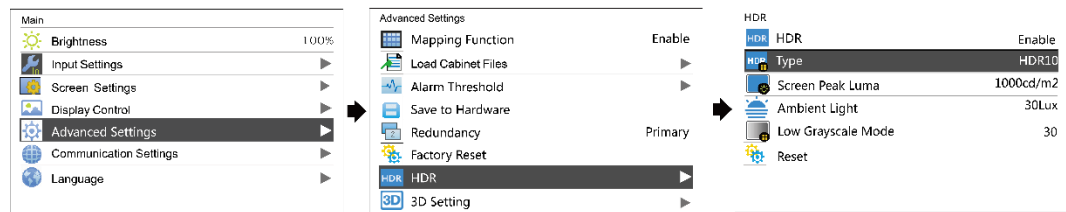
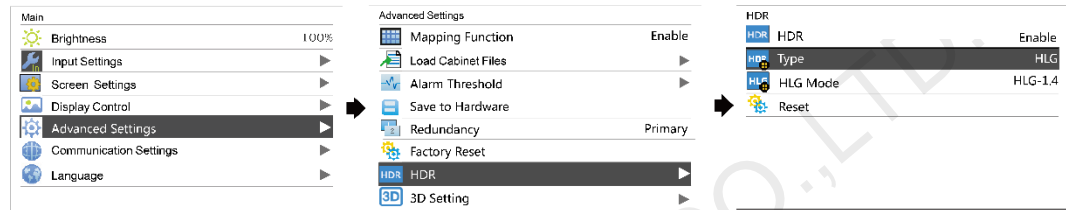

Figure 7-15 HLG operation menu



## Method 2: Operation in NovaLCT

Step 1 Run NovaLCT and choose **Settings > Adjust screen effect**.

Step 2 Under **HDR Parameter Settings**, select **Enable**.

Step 3 Click the drop-down box to select an HDR standard (HDR10 and HLG supported).

Step 4 Set the HDR parameters to adjust the display effect.

- When the input source is HDR10, you can drag the sliders to adjust the peak screen brightness, ambient light and low grayscale mode in real time.
- When the input source is HLG, you can click to select one HLG mode from the 7 modes, namely HLG1 (300 nits) to HLG7 (1700 nits).

Figure 7-16 Selecting Adjust screen effect

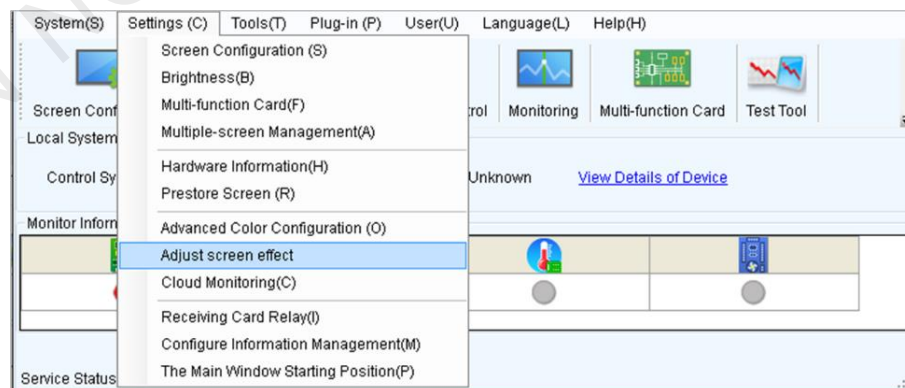

Figure 7-17 Adjusting screen effect (for HDR10)

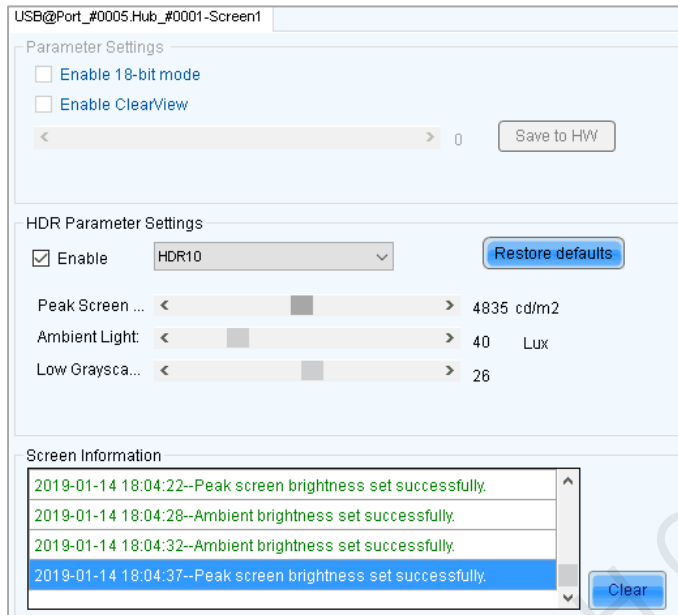
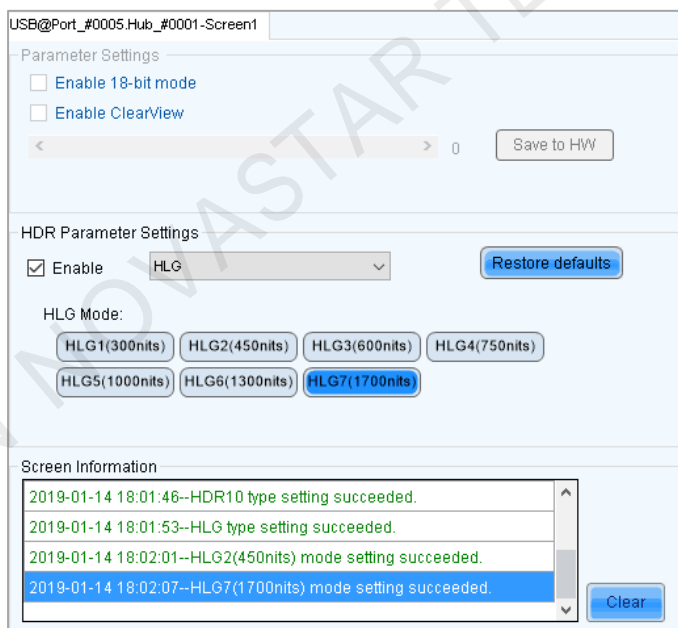
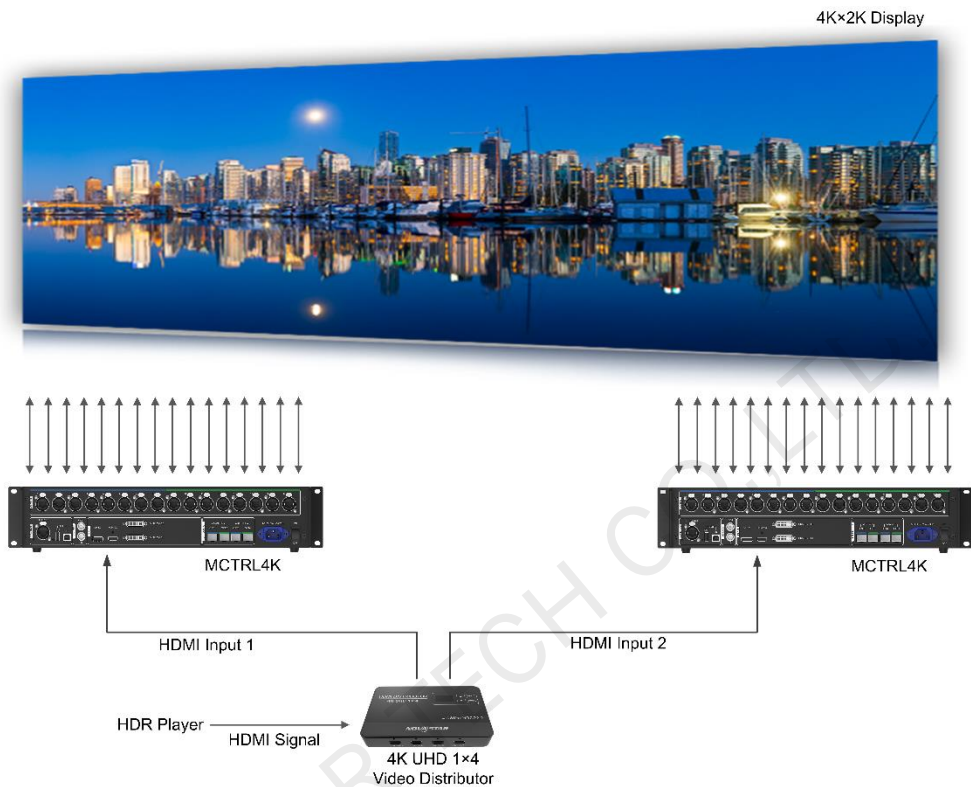

Figure 7-18 Adjusting screen effect (for HLG)



## Application



### Note:

- The HDR function supports only the HDMI input connector.
- The HDR function supports only the 10-bit input source.
- The HDR function and the calibration function of support software cannot be enabled at the same time.
- In NovaLCT, the HDR and ClearView functions cannot be enabled at the same time.
- Using the HDR function will reduce the loading capacity of the MCTRL4K by half because the HDR video source is 10-bit. Please refer to the diagram above and work out a connection solution in advance.

## 7.5.8 3D Settings

This function works with the 3D emitter EMT200 and 3D glasses to allow users to experience 3D effects on LED screen. For detailed usage, see *3D Emitter EMT200 Quick Start Guide*.

### Applications

- Application 1: EMT200 connected behind the last receiving card

Figure 7-19 Application 1

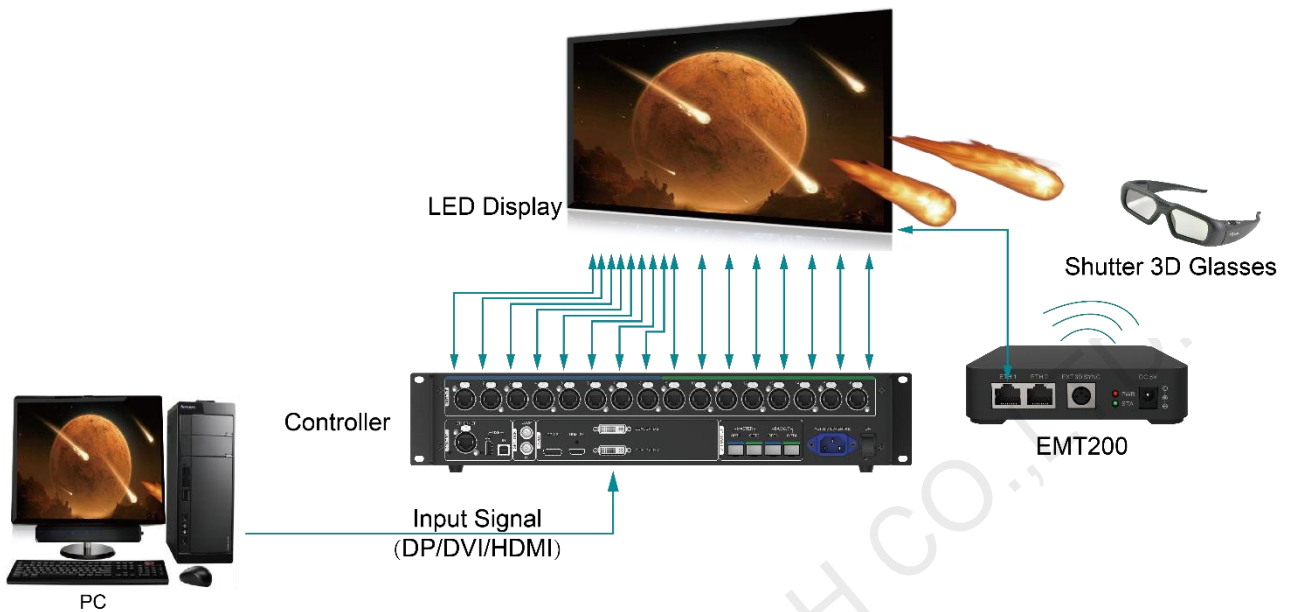

- Application 2: EMT200 connected between controller and receiving card

Figure 7-20 Application 2

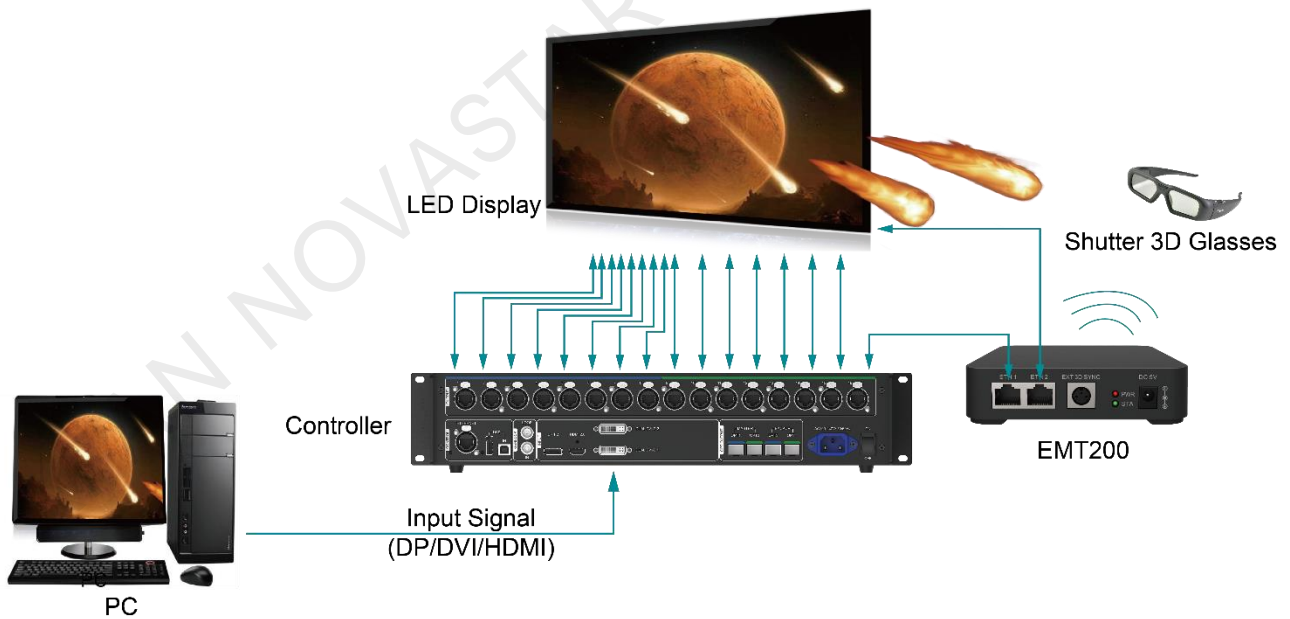

### 3D Function Settings

Step 1 Connect hardware devices according to the corresponding application.

Step 2 Enable 3D function by using any of the following methods and set 3D parameters.

- Method 1: On LCD menu
  1. Press the knob to enter the main menu.
    - If the input source is DUAL DVI, go to 2.

- If the input source is HDMI/DP, go to 4.
- 2. Choose **Input Settings > Input Mode > DVI Mode > Mosaic**.
- 3. Press the **BACK** button to return to the main menu.
- 4. Choose **Advanced Settings > 3D Setting** to enter its submenu.
- 5. Enable 3D and set the video source format and eye priority mode.
  - Video source format: Set the format according to the format of the video source. The options include **SBS** (side-by-side), **TAB** (top-and-bottom) and **Frame SEQ** (frame sequential).
  - Eye priority mode: Set the priority according to the 3D glasses. The options include right eye and left eye.

Figure 7-21 3D settings on LCD menu

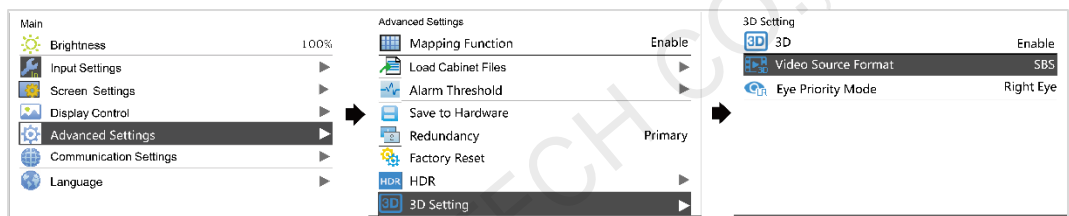

- Method 2: In NovaLCT
  1. Start NovaLCT, choose **Screen Configuration > Sending Card**, select **Enable** in 3D function area and click **Settings** to enter the 3D parameter settings page.

Figure 7-22 Toolbar

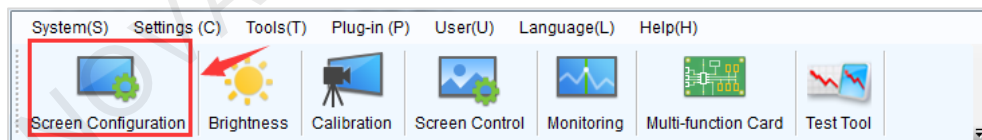
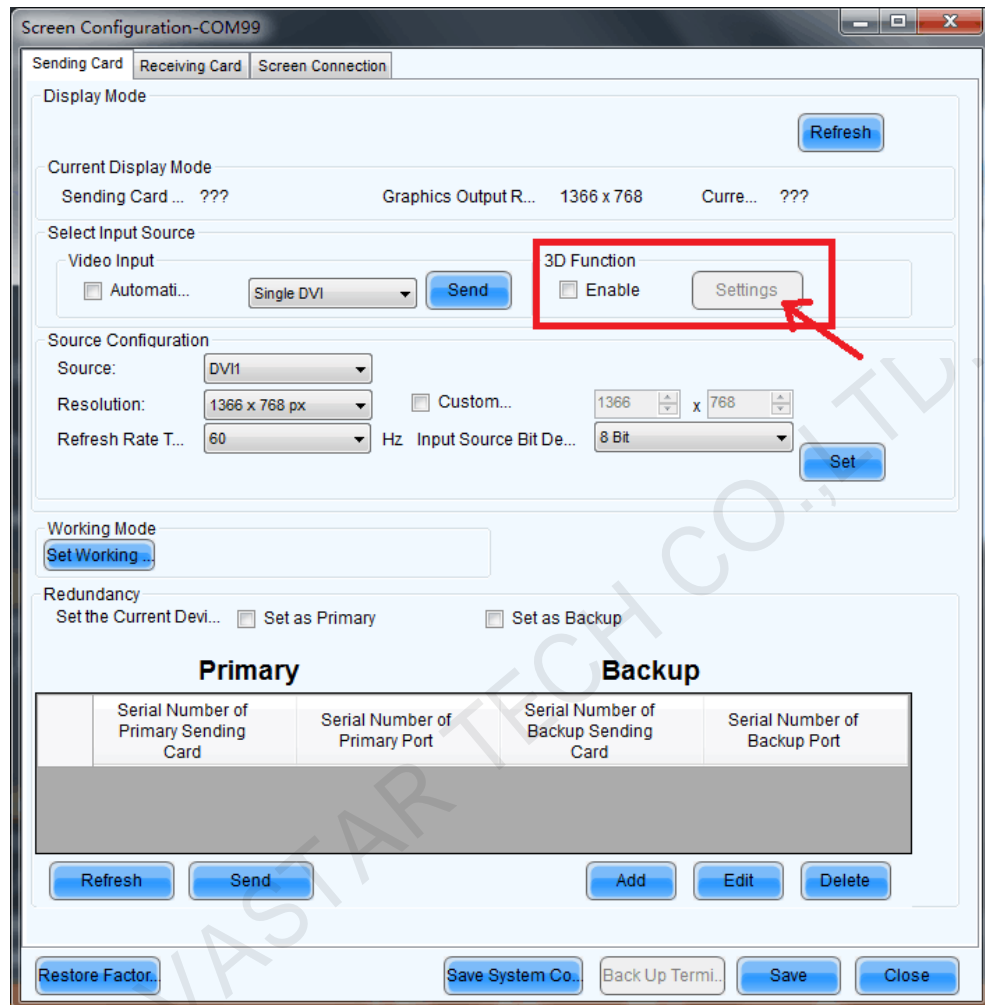

Figure 7-23 Screen configuration page



2. Set 3D function parameters. Then, click **Save to File** to save the parameters you set as a file. Or, you can click **Load from File** to load an existing 3D configuration file.
  - Mode Selection: This parameter is available when the video source is Dual DVI, as shown in [Figure 7-24](#). It is unavailable when the video source is HDMI or DP.

Figure 7-24 Setting 3D parameters - DVI



- **Right Eye Start:** When you set the video source format as side-by-side or top-and-bottom, you must set the right eye start position.
- **Signal Delay Time:** When the input source is DP/HDMI, you must set this parameter. Please set this time as required to make sure that the left and right eye image switching of the 3D glasses is in sync with the image switching on the display.

Figure 7-25 Setting 3D parameters - HDMI/DP

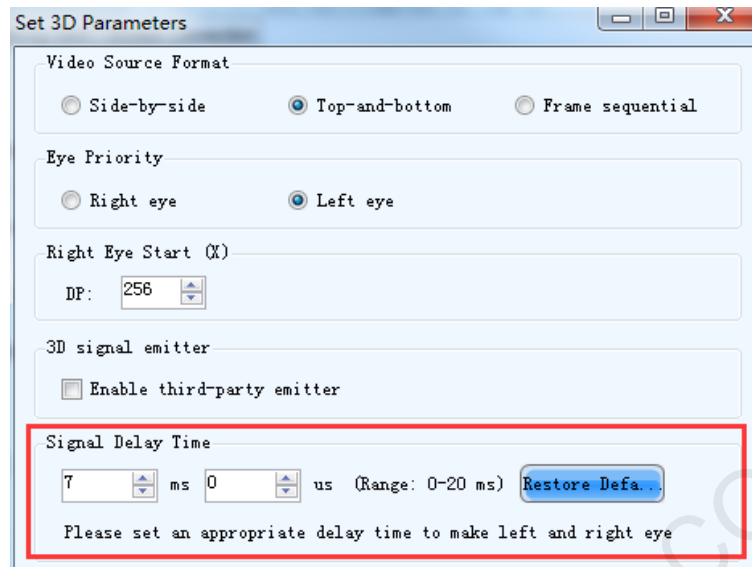

3. On the screen configuration page, click **Save** to save current configuration parameters to the controller.

Note:

- The 3D and low latency functions cannot be enabled at the same time.
- The 3D function and the calibration function of support software cannot be enabled at the same time.
- When the advanced screen configuration is enabled, 3D function is not supported.
- When the input source is DVI, DVI1 loads the images for left eye, and DVI2 loads the images for right eye. When the 3D function is in use, the input mode cannot be switched to multi-card mode.
- When the video source format is set to side-by-side or top-and-bottom, the frame frequency of Ethernet output will be doubled (for example, if the frequency of input source is 60 Hz, the frequency of Ethernet output will be 120 Hz), and the loading capacity of Ethernet port will be reduced by half.

### 7.5.9 Hardware Version

View the hardware version of current device.

Note:

To upgrade the hardware version, send the upgrade file to the MCTRL4K via NovaLCT.

## 7.6 Communication Settings

Set the communication mode and network parameters.

Figure 7-26 Communication settings

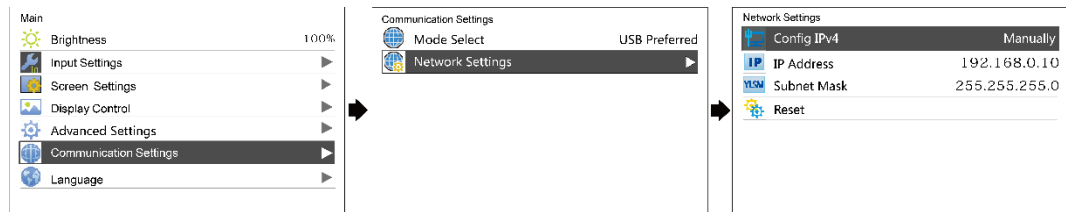

## Communication Mode

The controller connects to PC via the USB port or ETHERNET port. The communication modes include **USB Preferred** and **LAN Preferred**.

- If **USB Preferred** is selected, the PC prefers to communicate with the controller via the USB port.
- If **LAN Preferred** is selected, the PC prefers to communicate with the controller via the ETHERNET port.

## Network Settings

Network settings can be manual or automatic.

- Manual settings parameters include controller IP address and subnet mask.
- Automatic settings can read the network parameters automatically.
- Reset: Reset the network parameters to default values.

## 7.7 Language

Change the UI language of the MCTRL4K unit.

# 8 Operations on PC

## 8.1 Individual Gamma Adjustment for RGB

The MCTRL4K supports individual Gamma adjustment for RGB when the bit depth of input source is 10-bit or 12-bit, which effectively controls image non-uniformity under low grayscale and white balance offset to improve image quality.

- Step 1 Run NovaLCT, click **Screen Configuration**, choose the current operation communication port and click **Next**.
- Step 2 On the **Sending Card** tab page, select the corresponding input source bit depth and click **Set**.
- Step 3 On the home page of NovaLCT, choose **Brightness > Manually Adjustment**.
- Step 4 Under **Advanced Settings**, choose **Gamma > Custom Gamma Adjustment** and click **Configuration** to enter the **Gamma Adjustment** page.
- Step 5 Adjust **Red Gamma**, **Green Gamma** and **Blue Gamma**, respectively.
- Step 6 Click **Send**.
- Step 7 Close the **Gamma Adjustment** page. On the **Brightness Adjustment** page, click **Save to HW**.

Figure 8-1 Gamma adjustment page

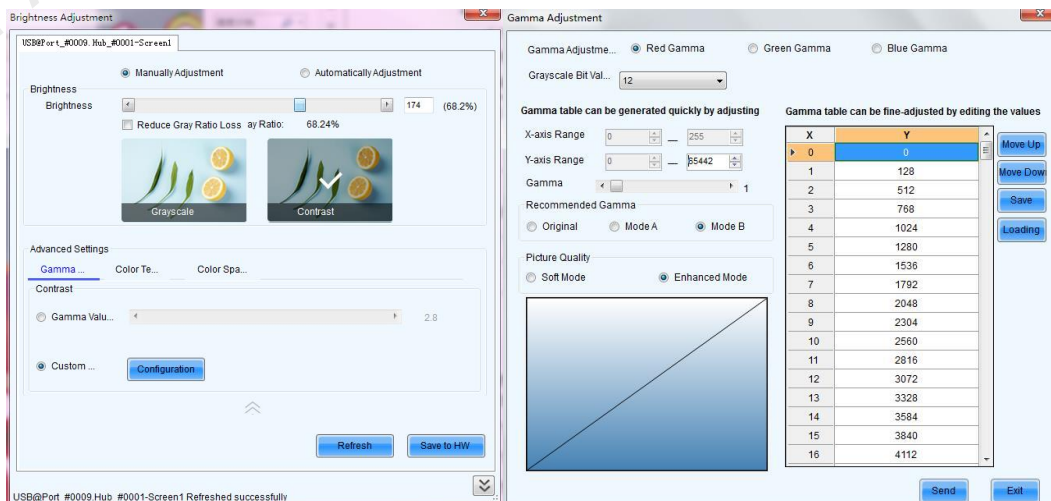

**Note:**

When the bit depth of input source is 8-bit, the individual Gamma adjustment for RGB is realized by AXs (V4.6.0.0) series receiving cards.

## 8.2 Low Latency

The MCTRL4K supports a low latency of less than 1 ms (when the start position of image is 0). Low latency is used to reduce the time delay between the input of video signal to the controller and the corresponding output. To use the low latency function, you must ensure that each Ethernet port loads the cabinets vertically during screen configuration, as shown in [Figure 8-2](#).

Figure 8-2 Loading vertically

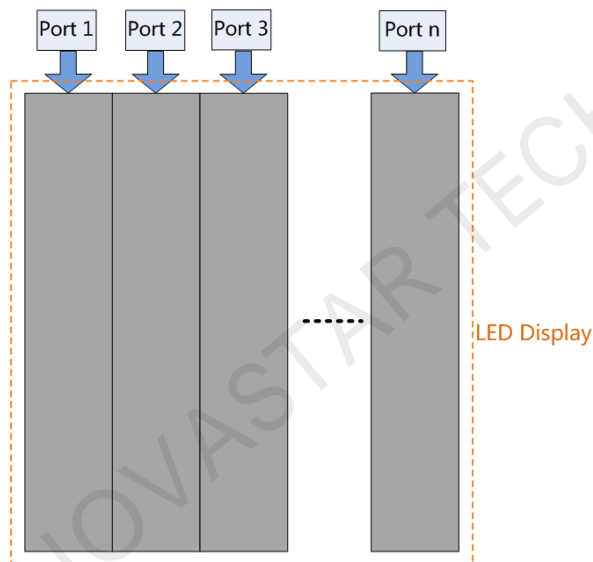

- Step 1 Run NovaLCT, choose **Screen Configuration** and enter the **Sending Card** tab page.
- Step 2 Select **Enable Low Latency**.
- Step 3 Click **Save System Configuration File** and **Save**.

Figure 8-3 Low latency

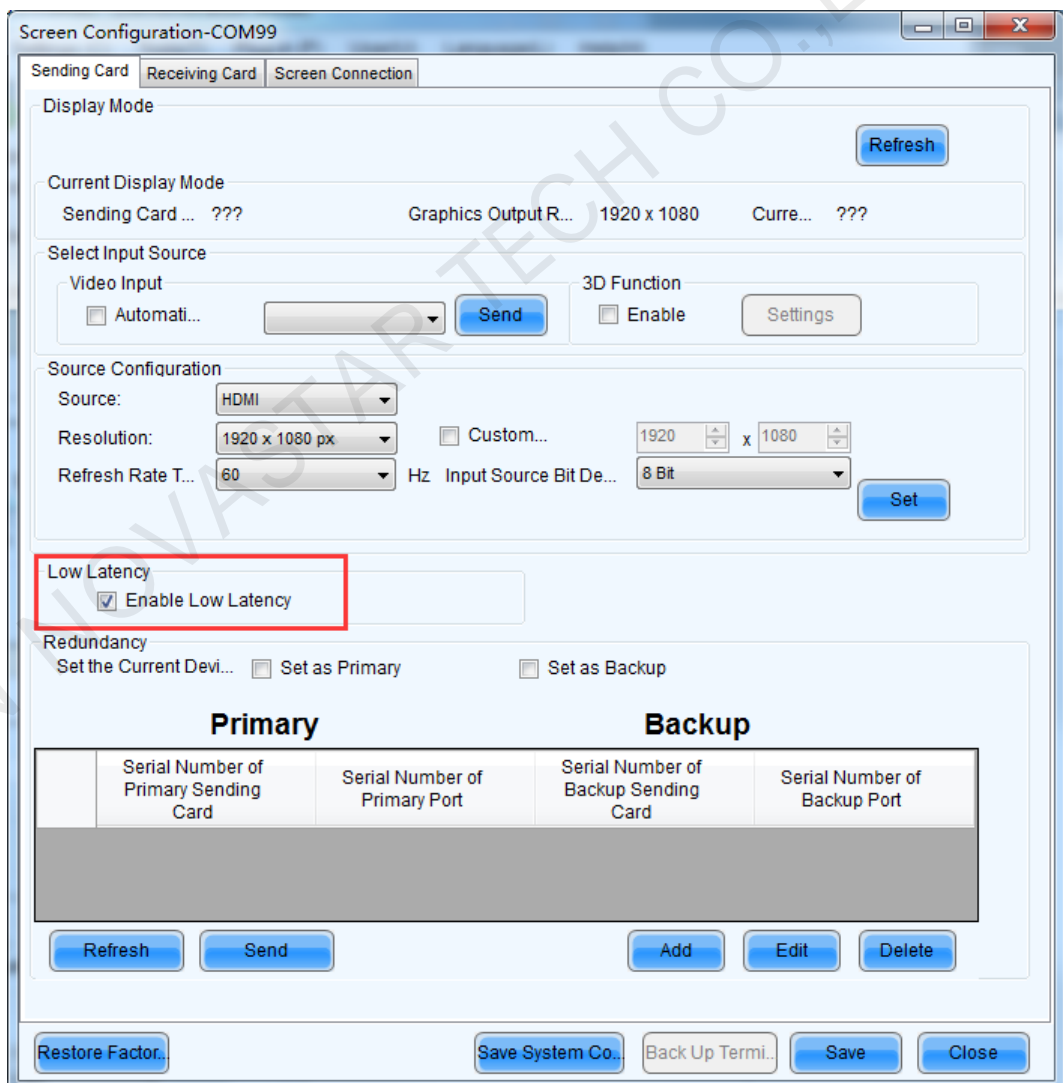
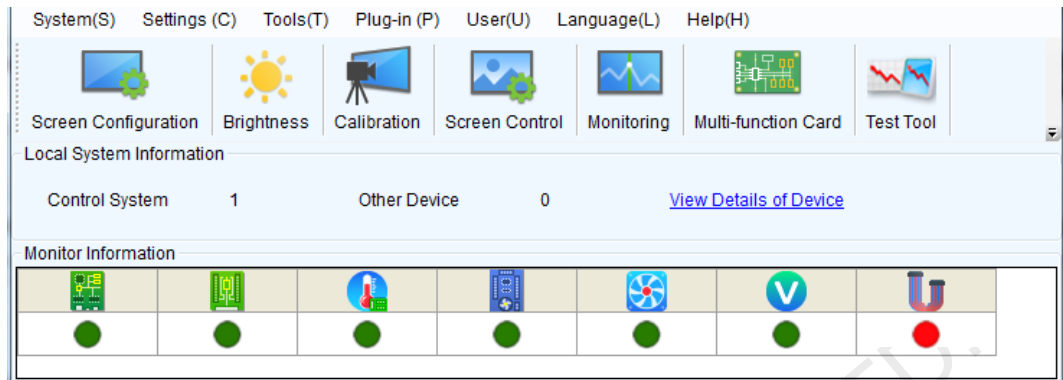

Notice:

- The low latency function is supported when the input source is DP/HDMI.
- The low latency and Genlock functions cannot be enabled at the same time.

- When the low latency function is enabled, the offset of image cannot exceed the size of input source.

### 8.3 Input Source Bit Depth

Set the bit depth of input source, including 8-bit, 10-bit and 12-bit.

- Step 1 Run NovalCT and choose **Screen Configuration > Sending Card**.
- Step 2 Click the drop-down box next to **Input Source Bit Depth** and choose a bit depth.
- Step 3 Click **Save System Configuration File** and **Save**.

Figure 8-4 Input source bit depth

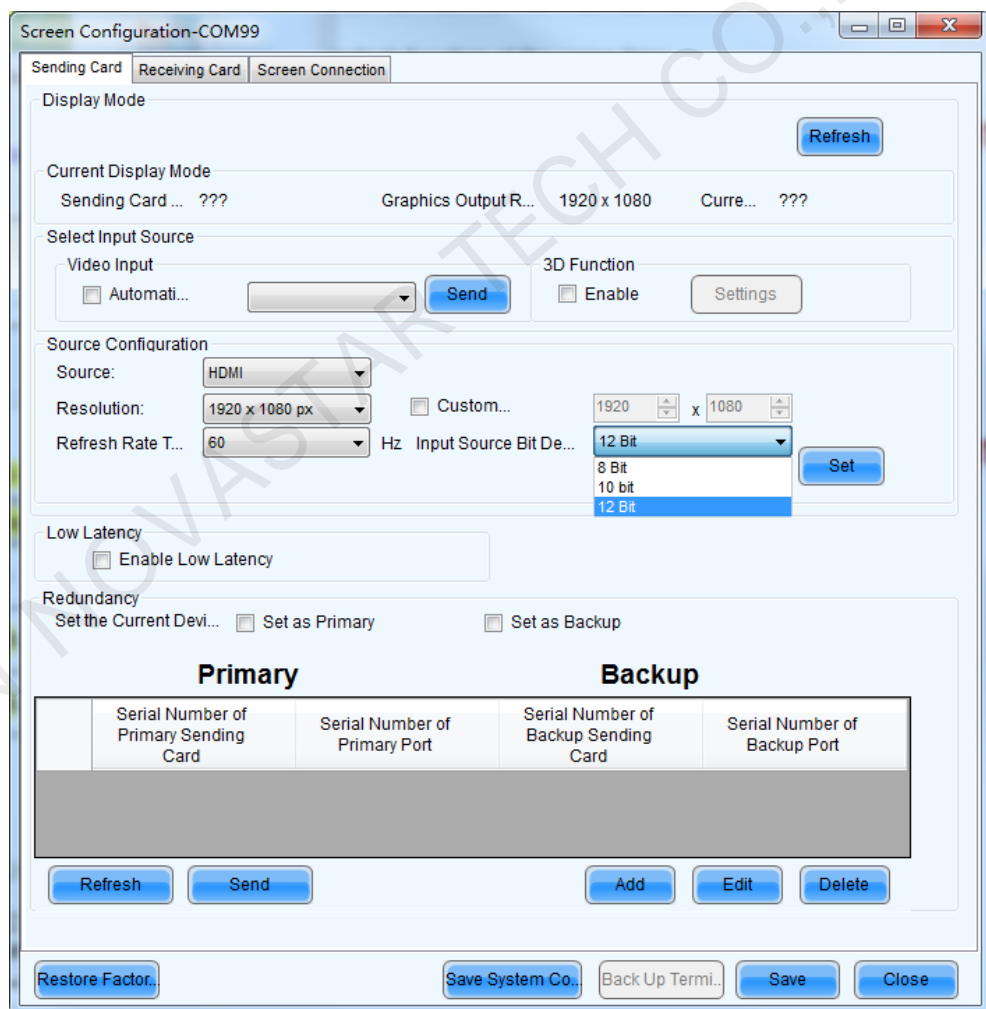

Table 8-1 Input source bit depth adjustment

Bit Depth	Description
8 bit	The loading capacity of the MCTRL4K will not be reduced.

10 bit	The loading capacity of the MCTRL4K will be reduced by half.
12 bit	The loading capacity of the MCTRL4K will be reduced by half.

## 8.4 Operations on Web Page

The MCTRL4K supports Web control functions, so the screen configurations can be easily and quickly performed on a PC or mobile device.

Note:

For LED screen configuration via Web, the Google Chrome browser (Chrome 50 or later) is recommended.

### 8.4.1 Environment Configuration

Figure 8-5 Environment configuration diagram



Step 2 Connect the MCTRL4K to a PC (or a mobile device) via Ethernet cable or router.

Step 3 Obtain the IP address of the MCTRL4K.

Step 4 On the PC (or mobile device), enter "**http//the above device IP address**" and press **Enter** to go to the device control page automatically.

Notice:

The MCTRL4K and PC (or mobile device) must be on the same LAN.

## 8.4.2 Operations

Figure 8-6 Web control page

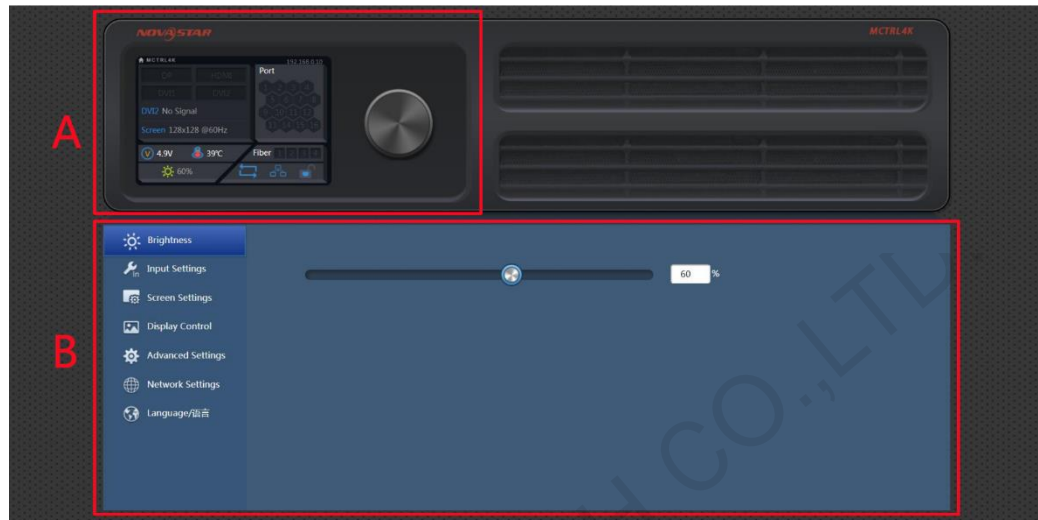

- Area A: Hardware connection statuses and loading capacities of the input, output and other connectors on the MCTRL4K. For details, see chapter 6 Home Screen.
- Area B: Operations can be done in this area. For details, see chapter 7 Menu Operations.

Click the menu bar on the left of area B to select the option to be adjusted, and the corresponding operations can be done on the right.

## 8.5 Software Operations on PC

### 8.5.1 NovaLCT

Connect the MCTRL4K to the control computer installed with NovaLCT (V5.2.0 or later) with USB cable to perform screen configuration, brightness adjustment, calibration, display control, monitoring, etc. For details on their operations, see *NovaLCT LED Configuration Tool for Synchronous System User Guide*.

Figure 8-7 User interface of NovaLCT

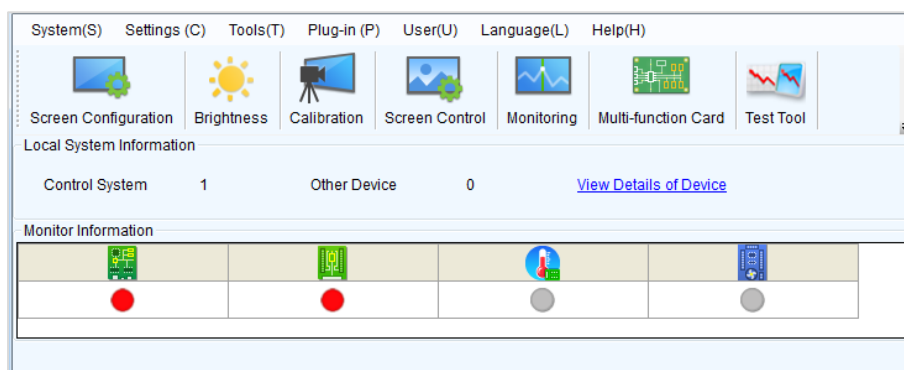

## 8.5.2 SmartLCT

Connect the MCTRL4K to the control computer installed with SmartLCT (V3.2.0 or later) with USB cable to perform building-block cabinet configuration, seam brightness adjustment, real-time monitoring, brightness adjustment, hot backup, etc. For details on their operations, see *SmartLCT User Manual*.

Figure 8-8 User interface of SmartLCT



## 8.6 Firmware Update



### 8.6.1 NovaLCT

In NovaLCT, perform the following steps to update the MCTRL4K firmware.

- Step 1 Run NovaLCT and choose **User > Advanced Synchronous System User Login** and log in as an advanced user.
- Step 2 Type the secret code "**admin**" to enter the program loading page.
- Step 3 Click **Browse** to select the update program path and then click **Update**.

### 8.6.2 SmartLCT

In SmartLCT, perform the following steps to update the MCTRL4K firmware.

- Step 1 Start SmartLCT and enter the V-Sender page.
- Step 2 In the properties area on the right, click  to enter the **Firmware Upgrade** page.
- Step 3 Click  to select the update program path.
- Step 4 Click **Update**.

# 9 Specifications

Electrical Parameters	Input voltage	AC 100 V–240 V, 50/60 Hz
	Rated power consumption	30 W
Operating Environment	Temperature	-20°C–60°C
	Humidity	10% RH–90% RH, non-condensing
Storage Environment	Temperature	-20°C–70°C
	Humidity	10% RH–90% RH, non-condensing
Physical Specification	Dimensions	482.6 mm × 372.0 mm × 96.0 mm
	Weight	4.6 kg
Packing Information	Carrying case	530 mm × 420 mm × 193 mm White cardboard box
	Accessory box	405 mm × 290 mm × 48 mm White cardboard box Accessories: 1 × power cord, 1 × Ethernet cable, 1 × USB cable, 1 × HDMI cable and 1 × DP cable
	Packing box	550 mm × 440 mm × 210 mm Craft paper box
Certifications	FCC, EMC, LVD, RoHS, UL&CUL, EAC, CB, IC, KC, RCM	